

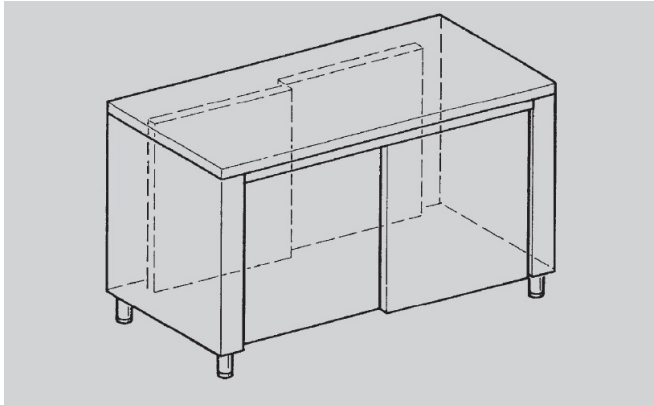

PREPARATION - EUCLIDE

TAP147



Meubles traversants

SPÉCIFICATIONS TECHNIQUES:

Dimensions exterieure - LxPxH (cm)	140x70x85
------------------------------------	-----------

SPÉCIFICATIONS SUPPLÉMENTAIRES:

Poids (kg)	125
Volume (m3)	1,1